

# SEMiX603GB066HDs



SEMiX® 3s

## Trench IGBT Modules

### SEMiX603GB066HDs

#### Features

- Homogeneous Si
- Trench = Trenchgate technology
- $V_{CE(sat)}$  with positive temperature coefficient
- UL recognised file no. E63532

#### Typical Applications\*

- Matrix Converter
- Resonant Inverter
- Current Source Inverter

#### Remarks

- Case temperature limited to  $T_C=125^\circ\text{C}$  max.
- Product reliability results are valid for  $T_j=150^\circ\text{C}$
- For short circuit: Soft  $R_{Goff}$  recommended
- Take care of over-voltage caused by stray inductance

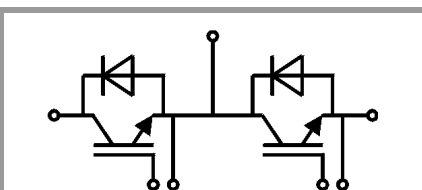

GB

Absolute Maximum Ratings				
Symbol	Conditions	Values	Unit	
<b>IGBT</b>				
$V_{CES}$		600	V	
$I_C$	$T_j = 175^\circ\text{C}$	$T_c = 25^\circ\text{C}$	720	A
		$T_c = 80^\circ\text{C}$	541	A
$I_{Cnom}$		600	A	
$I_{CRM}$	$I_{CRM} = 2 \times I_{Cnom}$	1200	A	
$V_{GES}$		-20 ... 20	V	
$t_{psc}$	$V_{CC} = 360\text{ V}$	$T_j = 150^\circ\text{C}$	6	$\mu\text{s}$
	$V_{GE} \leq 15\text{ V}$			
	$V_{CES} \leq 600\text{ V}$			
$T_j$		-40 ... 175	$^\circ\text{C}$	
<b>Inverse diode</b>				
$I_F$	$T_j = 175^\circ\text{C}$	$T_c = 25^\circ\text{C}$	771	A
		$T_c = 80^\circ\text{C}$	562	A
$I_{Fnom}$		600	A	
$I_{FRM}$	$I_{FRM} = 2 \times I_{Fnom}$	1200	A	
$I_{FSM}$	$t_p = 10\text{ ms, sin } 180^\circ, T_j = 25^\circ\text{C}$	1800	A	
$T_j$		-40 ... 175	$^\circ\text{C}$	
<b>Module</b>				
$I_{t(RMS)}$	$T_{terminal} = 80^\circ\text{C}$	600	A	
$T_{stg}$		-40 ... 125	$^\circ\text{C}$	
$V_{isol}$	AC sinus 50Hz, $t = 1\text{ min}$	4000	V	

Characteristics					
Symbol	Conditions	min.	typ.	max.	Unit
<b>IGBT</b>					
$V_{CE(sat)}$	$I_C = 600\text{ A}$ $V_{GE} = 15\text{ V}$ chipelevel	$T_j = 25^\circ\text{C}$	1.45	1.85	V
		$T_j = 150^\circ\text{C}$	1.7	2.1	V
$V_{CE0}$		$T_j = 25^\circ\text{C}$	0.9	1	V
		$T_j = 150^\circ\text{C}$	0.85	0.9	V
$r_{CE}$	$V_{GE} = 15\text{ V}$	$T_j = 25^\circ\text{C}$	0.9	1.4	$\text{m}\Omega$
		$T_j = 150^\circ\text{C}$	1.4	2.0	$\text{m}\Omega$
$V_{GE(th)}$	$V_{GE}=V_{CE}, I_C = 9.6\text{ mA}$	5	5.8	6.5	V
$I_{CES}$	$V_{GE} = 0\text{ V}$ $V_{CE} = 600\text{ V}$	$T_j = 25^\circ\text{C}$	0.15	0.45	$\text{mA}$
		$T_j = 150^\circ\text{C}$			$\text{mA}$
$C_{ies}$	$V_{CE} = 25\text{ V}$ $V_{GE} = 0\text{ V}$	$f = 1\text{ MHz}$	37.0		$\text{nF}$
$C_{oes}$		$f = 1\text{ MHz}$	2.31		$\text{nF}$
$C_{res}$		$f = 1\text{ MHz}$	1.10		$\text{nF}$
$Q_G$	$V_{GE} = -8\text{ V...} + 15\text{ V}$		4800		$\text{nC}$
$R_{Gint}$	$T_j = 25^\circ\text{C}$		0.67		$\Omega$
$t_{d(on)}$	$V_{CC} = 300\text{ V}$	$T_j = 150^\circ\text{C}$	150		$\text{ns}$
$t_r$	$I_C = 600\text{ A}$ $V_{GE} = \pm 15\text{ V}$	$T_j = 150^\circ\text{C}$	145		$\text{ns}$
		$T_j = 150^\circ\text{C}$	12		$\text{mJ}$
$E_{on}$	$R_{Gon} = 3\ \Omega$	$T_j = 150^\circ\text{C}$	1050		$\text{ns}$
$t_{d(off)}$	$R_{Goff} = 3\ \Omega$	$T_j = 150^\circ\text{C}$	105		$\text{ns}$
$t_f$		$T_j = 150^\circ\text{C}$	43		$\text{mJ}$
$E_{off}$		$T_j = 150^\circ\text{C}$			$\text{mJ}$
$R_{th(j-c)}$	per IGBT			0.087	$\text{K/W}$

# SEMiX603GB066HDs



SEMiX® 3s

## Trench IGBT Modules

### SEMiX603GB066HDs

#### Features

- Homogeneous Si
- Trench = Trenchgate technology
- $V_{CE(sat)}$  with positive temperature coefficient
- UL recognised file no. E63532

#### Typical Applications\*

- Matrix Converter
- Resonant Inverter
- Current Source Inverter

#### Remarks

- Case temperature limited to  $T_C=125^\circ\text{C}$  max.
- Product reliability results are valid for  $T_j=150^\circ\text{C}$
- For short circuit: Soft  $R_{Goff}$  recommended
- Take care of over-voltage caused by stray inductance

Characteristics						
Symbol	Conditions		min.	typ.	max.	Unit
<b>Inverse diode</b>						
$V_F = V_{EC}$	$I_F = 600\text{ A}$ $V_{GE} = 0\text{ V}$ chip	$T_j = 25^\circ\text{C}$		1.4	1.60	V
		$T_j = 150^\circ\text{C}$		1.4	1.6	V
$V_{F0}$		$T_j = 25^\circ\text{C}$	0.9	1	1.1	V
		$T_j = 150^\circ\text{C}$	0.75	0.85	0.95	V
$r_F$		$T_j = 25^\circ\text{C}$	0.5	0.7	0.8	m $\Omega$
		$T_j = 150^\circ\text{C}$	0.8	0.9	1.1	m $\Omega$
$I_{RRM}$	$I_F = 600\text{ A}$	$T_j = 150^\circ\text{C}$		350		A
$Q_{rr}$	$di/dt_{off} = 3800\text{ A}/\mu\text{s}$ $V_{GE} = -8\text{ V}$	$T_j = 150^\circ\text{C}$		63		$\mu\text{C}$
$E_{rr}$	$V_{CC} = 300\text{ V}$	$T_j = 150^\circ\text{C}$		13		mJ
$R_{th(j-c)}$	per diode				0.11	K/W
<b>Module</b>						
$L_{CE}$				20		nH
$R_{CC'+EE'}$	res., terminal-chip	$T_C = 25^\circ\text{C}$		0.7		m $\Omega$
		$T_C = 125^\circ\text{C}$		1		m $\Omega$
$R_{th(c-s)}$	per module			0.04		K/W
$M_s$	to heat sink (M5)		3		5	Nm
$M_t$		to terminals (M6)	2.5		5	Nm
w					300	g
<b>Temperatur Sensor</b>						
$R_{100}$	$T_c=100^\circ\text{C}$ ( $R_{25}=5\text{ k}\Omega$ )			$493 \pm 5\%$		$\Omega$
$B_{100/125}$	$R(T)=R_{100}\exp[B_{100/125}(1/T-1/T_{100})]$ ; T[K];			$3550 \pm 2\%$		K

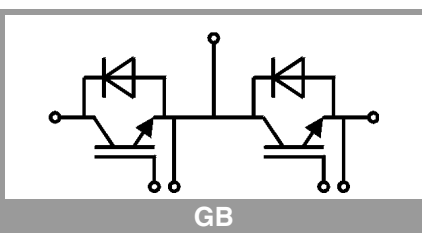

GB

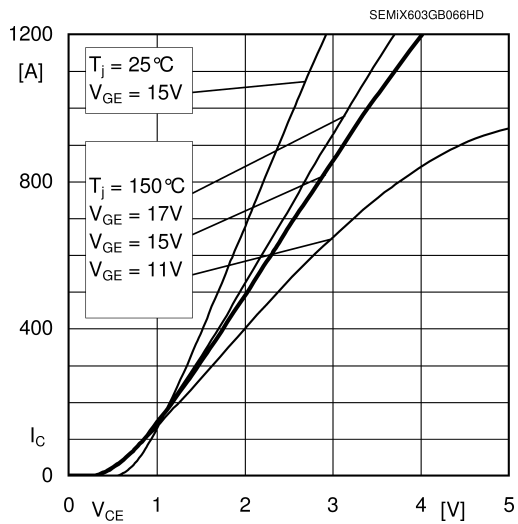

Fig. 1: Typ. output characteristic, inclusive  $R_{CC+EE}$

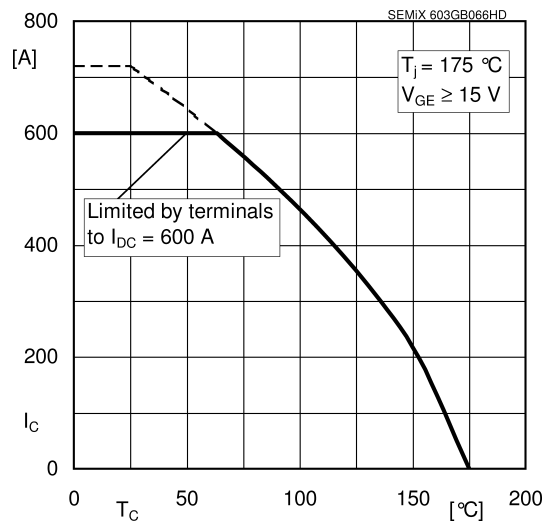

Fig. 2: Rated current vs. temperature  $I_C = f(T_C)$

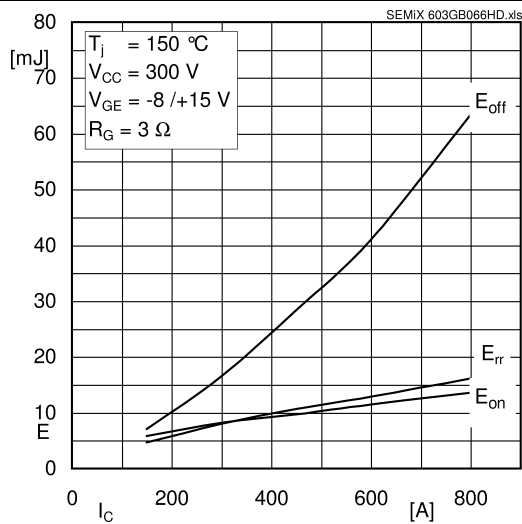

Fig. 3: Typ. turn-on /-off energy =  $f(I_C)$

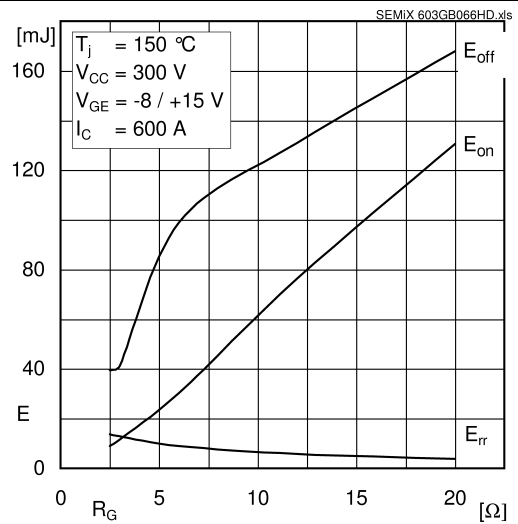

Fig. 4: Typ. turn-on /-off energy =  $f(R_G)$

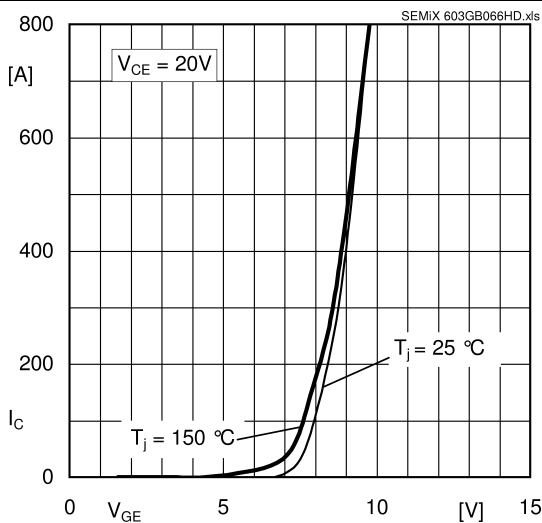

Fig. 5: Typ. transfer characteristic

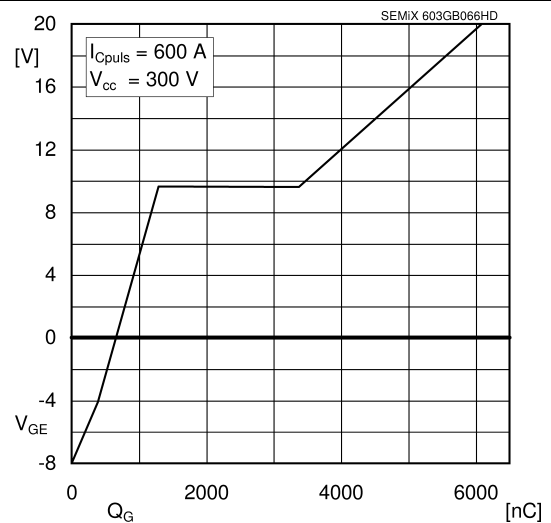

Fig. 6: Typ. gate charge characteristic

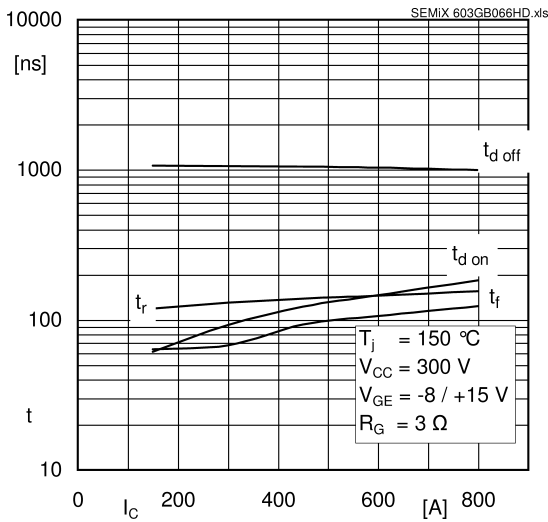

Fig. 7: Typ. switching times vs.  $I_C$

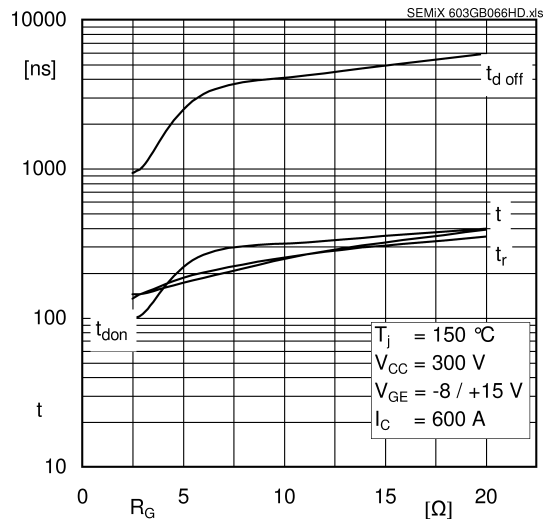

Fig. 8: Typ. switching times vs. gate resistor  $R_G$

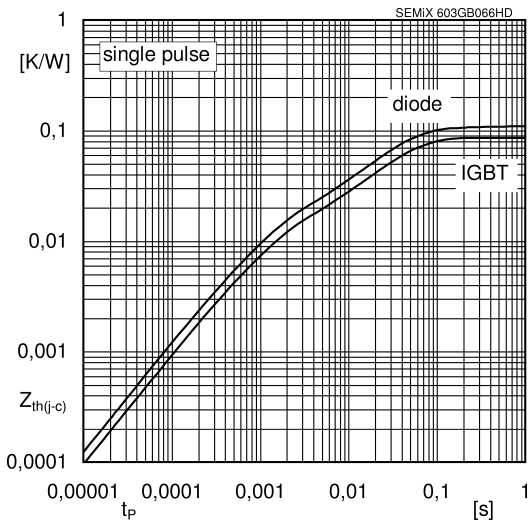

Fig. 9: Typ. transient thermal impedance

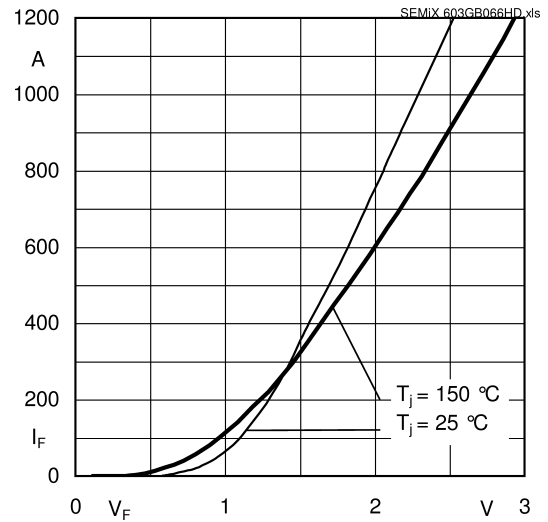

Fig. 10: Typ. CAL diode forward charact., incl.  $R_{CC+EE}$

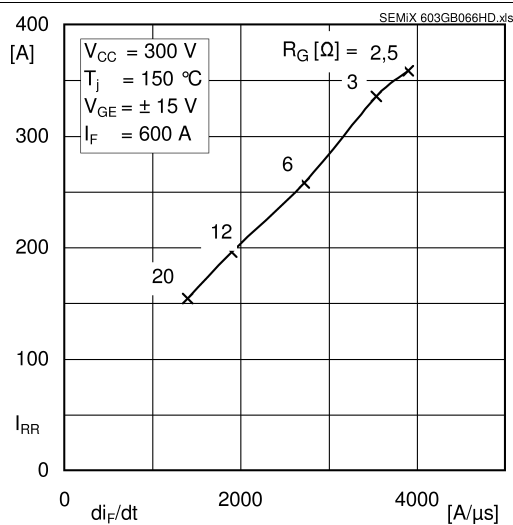

Fig. 11: Typ. CAL diode peak reverse recovery current

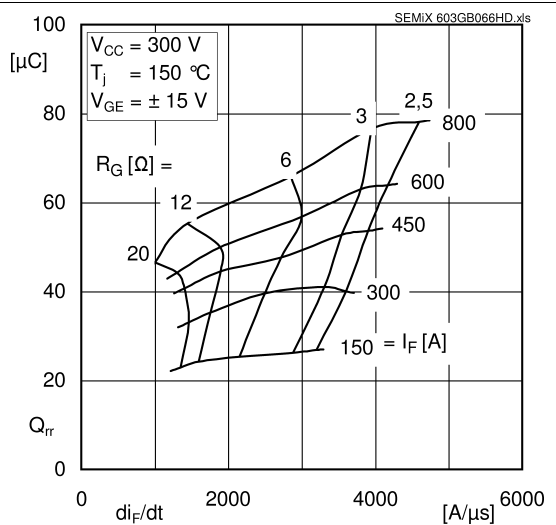
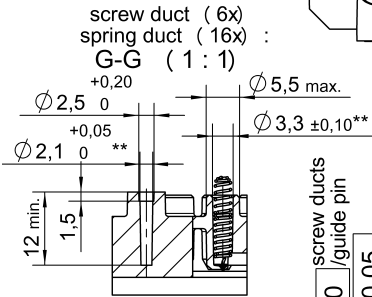
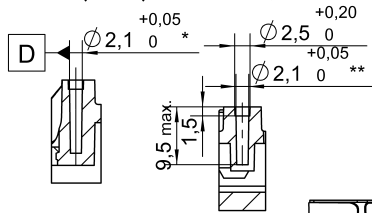

Fig. 12: Typ. CAL diode recovery charge

# SEMiX603GB066HDs

Case: SEMiX 3s

screw duct (left top) : F-F (1:1)  
 screw duct (1x centre) : H-H (1:1)



$\square$	0,3	connector 1-2 / 3-4
$\parallel$	0,2	each connector A

general tolerance:  
 ISO 2768-mK  
 ISO 8015

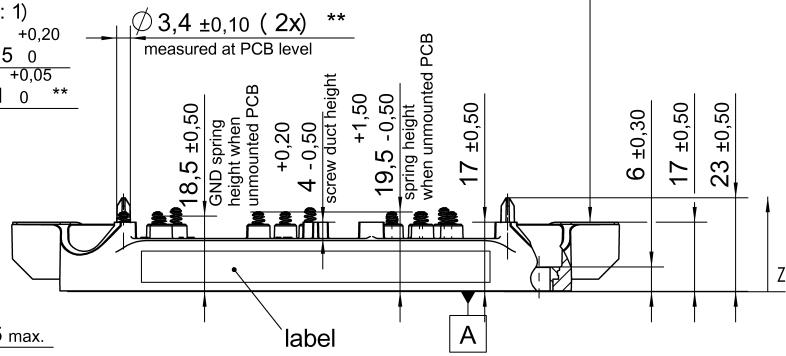

All measures in Z-direction valid when mounted to heat sink

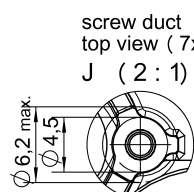
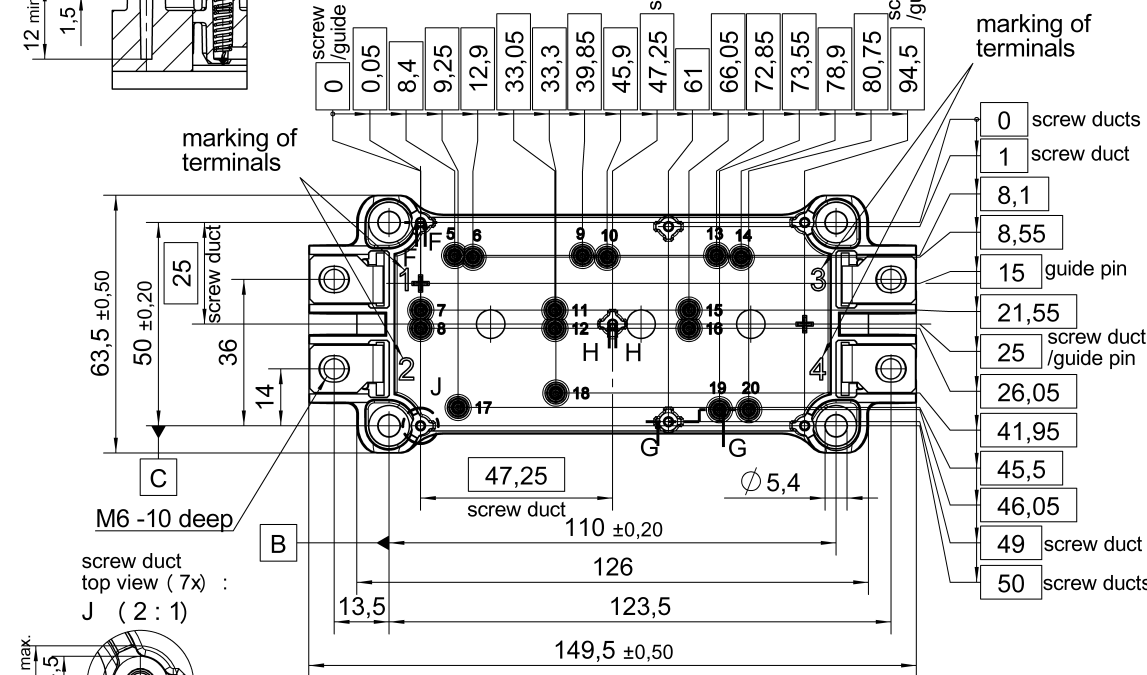

*screw duct left / top with	$\oplus$	$\phi$ 0,2	A	B	C	Rules for the contact PCB: - holes guidepins = $\phi$ 4 ± 0,1 / position tolerance ± 0,1 - holes for screws = $\phi$ 2,9 ± 0,1 / position tolerance ± 0,1 - spring contact pad = $\phi$ 3,6 ± 0,1 / position tolerance ± 0,1
**screw ducts / guide pins / spring ducts with	$\oplus$	$\phi$ 0,2	A	D	C	

SEMiX 3s

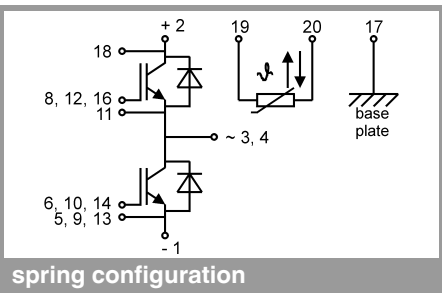

spring configuration

This is an electrostatic discharge sensitive device (ESDS), international standard IEC 60747-1, Chapter IX

\* The specifications of our components may not be considered as an assurance of component characteristics. Components have to be tested for the respective application. Adjustments may be necessary. The use of SEMIKRON products in life support appliances and systems is subject to prior specification and written approval by SEMIKRON. We therefore strongly recommend prior consultation of our staff.